

# Panthella Table

The fixture emits a soft and comfortable illumination. The hemispherical shade reflects the light downwards, and the material used ensures that the majority of the light is spread diffusely in the room from the surface of the shade.

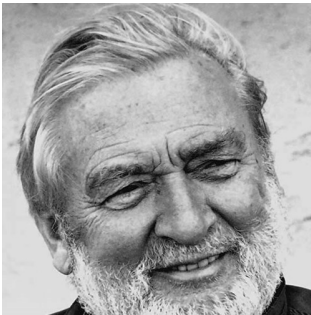

## Verner Panton

Verner Panton (1926-1998) is famous for his inspirational and colorful personality. A unique person with a special sense for color, shape, light function and space. Over the course of his career, Panton introduced a series of modern lamps with personalities unlike any of his Scandinavian contemporaries.

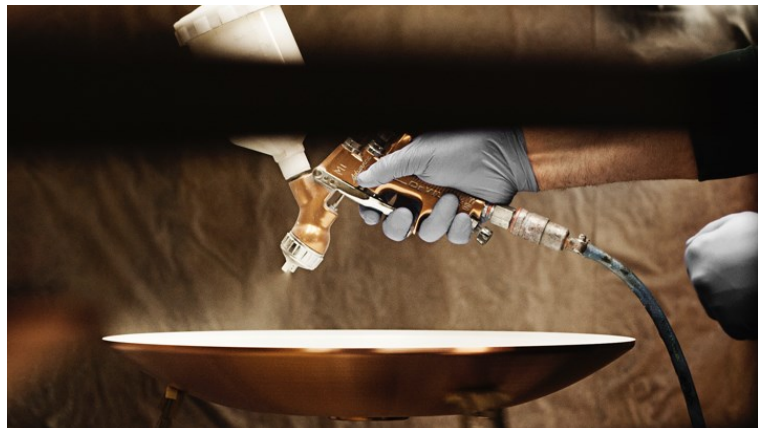

## Product info

### Finish

White opal acrylic.

### Materials

Shade: Injection moulded white opal acrylic. Base: White, injection moulded ABS. Housing: White, injection moulded ABS.

### Mounting

Cable type: Plastic cord with plug. Cable length: 2.1m. Light control: In-line switch on cord.

### Sizes and weights

Width x Height x Length (mm) | 400 x 580 x 400 Max 2.5 kg

### Class

Ingress protection IP20. Electric shock protection II w/o ground.

### Specification notes

The innovation of light sources is ongoing. Consequently we only inform about the max. wattages. On [www.louispoulsen.com](http://www.louispoulsen.com) we update a list of recommendable light sources.

### Light source

1x60W E27

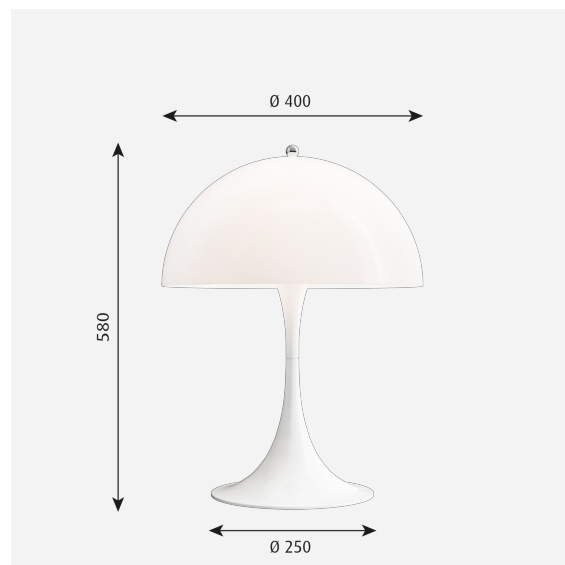

## Product family



Panthella Floor

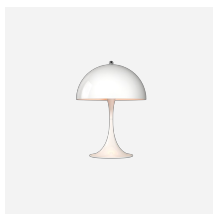

Panthella MINI

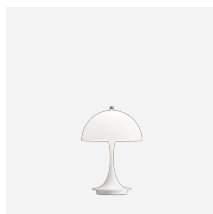

Panthella Portable

## Product variants

Light source	Colour	Class
1x60W E27	<input type="radio"/> Wht opal acryl	II

# Product description

Modern, all white, portable fixture.  
Terse and iconic design  
Matching floor version available.

---

## Mounting

Portable fixture plugs into standard wall outlet.

---

## Light description

The fixture emits glare free, comfortable light.  
Top hemispherical shade reflects light downwards

---

## Design

Verner Panton

---

## Material

Shade: opal acrylic, 1.5mm (0.06") thick.  
Base: injection molded white ABS, 1.5mm (0.06") thick.  
Switch: on/off, phenolic, on cord.  
Socket: Porcelain, medium base for A-19, frosted envelope lamps.

---

## Weight

2.462

---

## Finish

Wht opal acryl

# Light distribution diagrams

## Cartesian

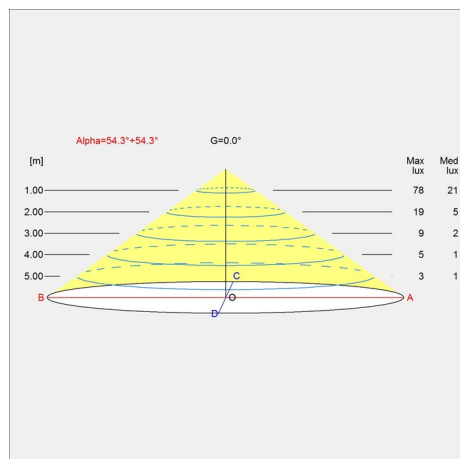

## Isolux

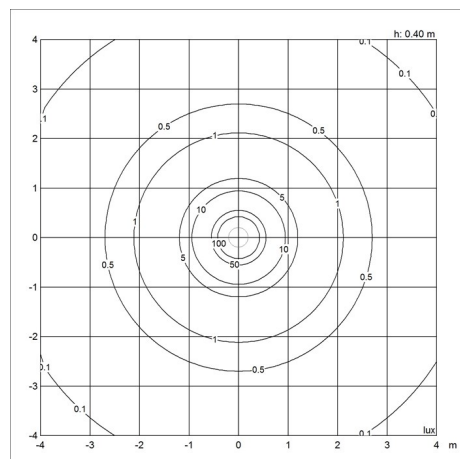

## Polar

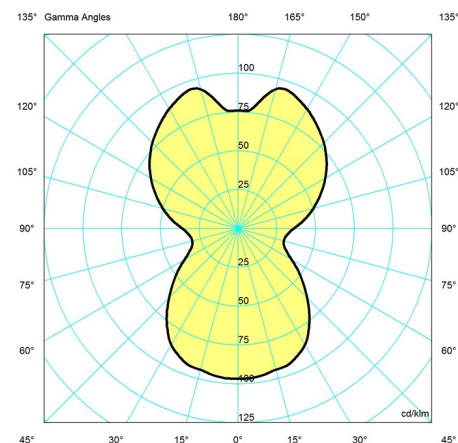

## Spare parts & accessories

### Product

PANTHELLA FLOOR/TABLE, NUT, CHROME  
 PANTHELLA TABLE, SHADE  
 PANTHELLA TABLE, CLEAR SHADEHOLDER

### Variant number

5744610049  
 5744610366  
 5744610544